

PILZ_86_D(1100)

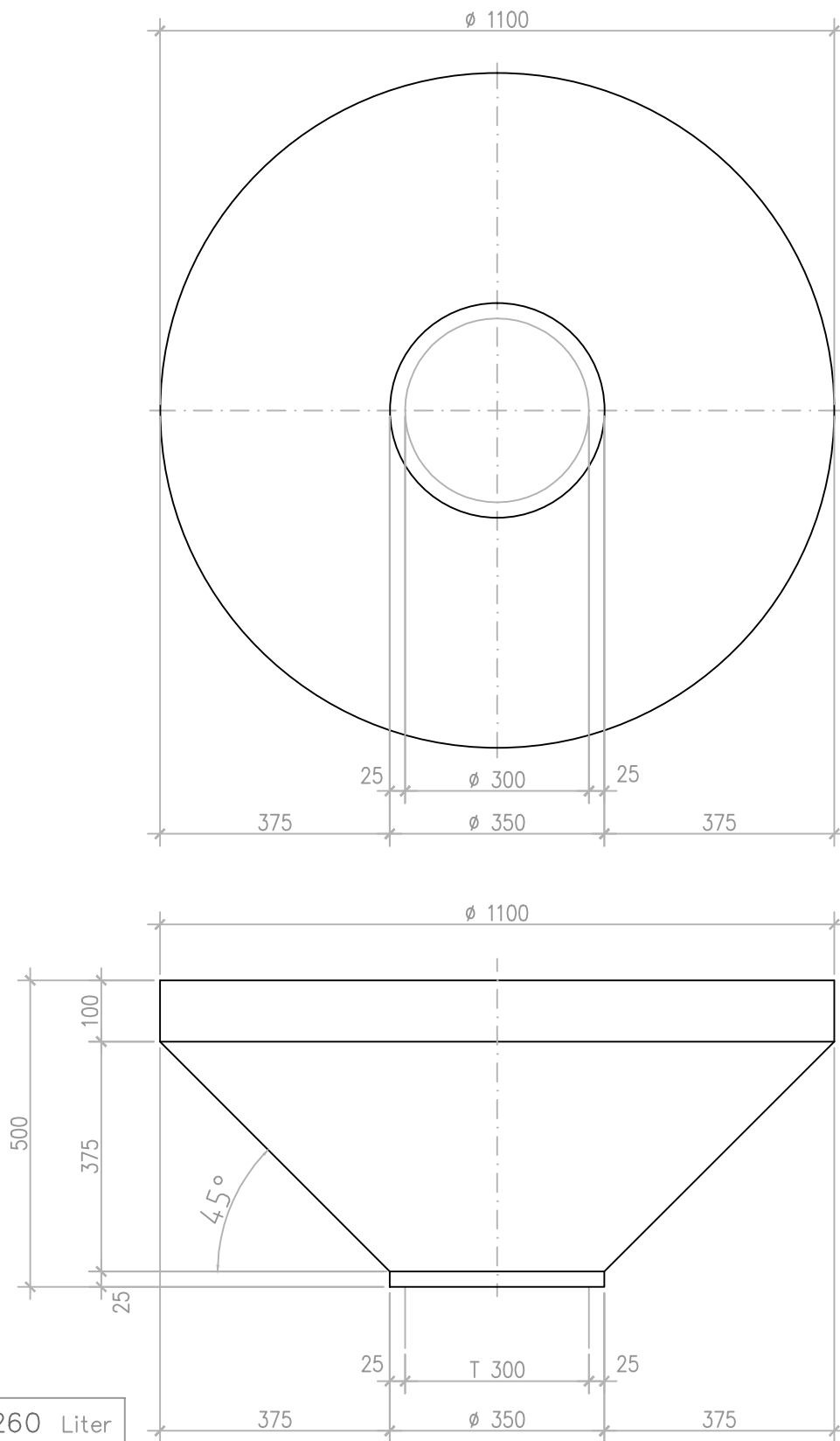

260 Liter
650 kg

ANLAGENUMMER: 86